

# Car Wash Ordering App for Better Queue

Eko Setyo Purwanto<sup>1\*</sup>, Mohamad Gandi Efendi<sup>2</sup>, Raditya Tohpati<sup>3</sup>,  
Patrick Marionatha<sup>4</sup>

<sup>1,2,3,4</sup> Computer Science Department, School of Computer Science,  
Bina Nusantara University,  
Jakarta, Indonesia 11480

eko.purwanto@binus.edu; mohamad.efendi001@binus.ac.id; raditya.tohpati@binus.ac.id;  
patrick.marionatha@binus.ac.id

\*Correspondence: eko.purwanto@binus.edu

**Abstract**– This study's goal is to create a booking application that is applied in a car wash. Seeing the rapid development of technology, one of which is the booking application, so many businesspeople take advantage of this booking application, for example, hotel booking applications, ticket bookings, and many more. But some business has not taken advantage of this booking application, one of which is the car wash business. Most car wash businesses still use manual methods in the process, from recording customer data and payments. In using this manual method, many problems occur. For example, recording incorrect data and counterfeiting money. Therefore, a study was conducted using the system development method, namely Waterfall. The waterfall method includes Analysis, Design, Coding, and Testing. The results obtained from this study are a Car Wash booking application utilizing the IoT topic, which is expected to help problems in the car wash business.

**Keywords:** Booking Car Wash; Car Wash; Waterfall; IoT

## I. INTRODUCTION

Each year, the type of vehicle that is created is more varied in terms of price and terms of appearance (Ahmed & Roorda, 2022). This makes the world community interested and want to buy a vehicle for him. 2020 in Indonesia, the number of vehicles in Indonesia reaches 136 million. Especially on the island of Java. Most of the motorcycles are purchased by residents and cars under them. When we have a vehicle, of course, we will take care of it so that it is durable and does not get damaged quickly. An example of caring for the vehicle is by washing the vehicle (Tony & Lin, 2021). Most people use car wash services in Indonesia, especially in the capital city of Indonesia. The name is steam cars (Kafiev et al., 2020). Using these services will make our vehicles clean only by spending RP. 50,000

(Harun et al., 2022). But there are drawbacks when washing our vehicles at vehicle steam services (Teow et al., 2022).

Namely, people don't know whether the vehicle place is open or closed and whether the place is crowded. We don't want to be hit by a long queue to wash the vehicle (Bu et al., 2022). Because when long queues hit us, it can ruin the schedule and make it ineffective (Pertama et al., 2022). Not only on steam, and most steam places still use the manual method for payment (Yuliarisa & Yandari, 2022) and registration (Dux-Santoy et al., 2022). Because nowadays, it is all technological. We must be updated so that we are not outdated (Muryani & Muqorobin, 2020).

Therefore, with problems that occur when washing vehicles want to make a product or application, there is A's Car Wash. This web-based application is useful for booking when we want to do a vehicle wash (Reddy & Savant, n.d.). So, by booking, we can determine the place and time we want to do the vehicle washing (Othman & Ramli, 2021). There are so many services that use the booking application system in the process, for example, hotel booking applications (Saito et al., 2019), tickets (Guan et al., 2020), and futsal fields (Putra, n.d.). We use IoT to distinguish our applications from existing applications (Shafique et al., 2020). In the working method, other applications do not use it. IoT that we will use for the technique is to use a QR Code to detect the data that will be inputted by the user when using this application (Tiwari, 2016). So, the QR Code in this application is used to check whether the data entered by the user and the data entered by the admin computer are the same or not. Thus, there is no fraud more secure in its use (Egelhofer & Lecheler, 2019). And the QR Code is also valid as a data detection to prove that the user has used applications and services at the steam washing place (Liu et al., 2008). With this application, it is hoped that it can overcome the problems in the car wash/steam business.

## II. METHODS

### 2.1 Theoretical Basis

#### 2.1.1 QR Code

QR Code is a barcode developed by Denso Wave, a division of Denso Cooperation from Japan. The publication of the QR code was carried out in 1994. This barcode is then widely used because its main functionality can convey information quickly and get a fast response as well. The content stored in the QR Code can be in the form of text, numbers, or binary codes. A QR Code contains a URL address, a web page, or an advertisement promoting a commercial product.

QR Code can be translated into a quick code or an abbreviation of Quick Response Code. The functionality of the QR Code is that it can be read quickly by the scanner (Scanner). On the official website, Denso Wave Incorporated (2014) claims to handle diverse data types such as numeric alphabet, kanji, kana, hiragana, symbol, binary, and control code and can encode up to 7,098 characters in one symbol. In addition, the QR Code is resistant to dirt and damage. An example of a QR code can be seen in Figure. 1.



Figure 1. QR Code

#### 2.1.2 Framework

A framework is a code framework that can be refined with specific classes or functions designed to address the problems at hand. It can be concluded that the framework is object-oriented and is a system design that is reused. The goal is to reduce re-creating the same code so that you can focus more on working on certain parts. The framework that we will use in making this product or application is Laravel (Laaziri et al., 2019). The reason we use Laravel as the framework is that the website becomes easier to develop, there is a namespace that helps us to organize and manage website resources, etc.

#### 2.1.3 Programming Code

PHP is the programming language that is used to create our website. It is the PHP programming language (Srivastava et al., 2022). PHP stands for Perl Hypertext Preprocessor and is code/script that will be executed on the server side. The server-side nature means that the script is executed by the server, and the results are sent to the browser. PHP is a programming code that works on a web server.

#### 2.1.4 Integrated Development Environment (IDE)

IDE is a computer program that has several facilities in software development. By using a particular IDE, all programming needs will be in one place, and sometimes other features are extremely useful in writing code (Bach et al., 2022). Windows, Linux, and macOS. Features include support for debugging, syntax highlighting, intelligent code completion, snippets, code refactoring, and embedded Git. Users can change the theme, keyboard shortcuts,

and preferences and install extensions that add additional functionality.

#### 2.1.5 Unified Modeling Language (UML)

UML is a language used to define, visualize, build, and document an information system. UML was developed as a tool for object-oriented design and analysis tools by Grady Booch, Jim Rumbaugh, and Ivar Jacobson. However, UML in the industry continues to increase. It is an open standard that makes it a popular modeling language in software and systems development.

The data modeling process describes the entire business process that will be carried out by an information system. The process model also describes the data involved in the process. One of the data modeling is using UML (Unified Modeling Language). The use of UML in this study includes Use Case diagrams, Use Case Scenarios, and Sequence diagrams.

#### 2.1.6 Database

A database is a collection of interconnected data (relationships). Generally, it can be interpreted as a combination of related and organized data elements (Castro-Medina et al., 2020). MySQL is an implementation of a relational database management system (RDBMS) which is distributed free of charge under the GPL (General Public License).

Users can freely use MySQL, but with limitations, the software may not be used as a commercial derivative product. MySQL is a derivative of one of the main concepts in databases. Especially for the selection or selection and data entry that allows data operations to be done quickly and automatically. This study uses MySQL as the database of the entire process carried out.

#### 2.1.7 Queue Discipline FIFO

First-In-First-Out queue (FIFO) is a method of solving the queuing problem that can be applied in a way where customers who come first or enter are assumed to be the first to leave (Saputra et al., 2020). If the vehicle service is issued, it will be completed first. This has been running by the queue flow where it is appropriate that the car service that enters the first time will be completed first. The FIFO algorithm is often used in various kinds of life problem solving and various applications and existing technologies. FIFO is an algorithm that is sequential and takes turns but remains on the path or path according to the first entry and then processed according to turn.

### 2.2 Waterfall

The system development method used is the waterfall. The advantage is that it is easy to apply (Chandran & das Aundhe, 2022). If all system requirements can be defined completely, explicitly, and correctly at the beginning of the project, software engineering (SE) can run well without problems, and problems with system requirements at the beginning of the project are more economical and less time wasted when compared to the problems that arise. In the next detention. The waterfall method has several stages, which are analysis, design, coding, and testing. The modeling of this method can be seen in Figure. 2.

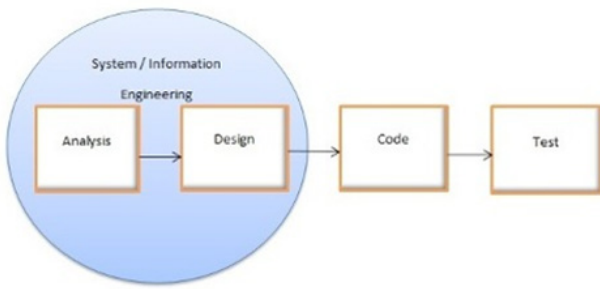

Figure 2. Waterfall Methodology

- Analysis**

In this stage, analyze things that happen in the car wash business and look for solutions to problems that occur, namely changing the registration system, which was originally done manually, into a booking system in the hope of making the queue better.
- Design**

In this stage, create a UI and UX for the application.
- Code**

In this stage, create a code for the application so the user can try the application.
- Test**

In this stage, do testing to check does the application have an error or bug and fix it.

The first stage is analysis. This stage is carried out to identify and gather requirements that help the technical team to understand the business context of an application. This stage also defines the output produced, the features possessed by the application, and the application functions. Furthermore, at the design stage, the application design is carried out from the planning results. This stage emphasizes the database and simple application interface design. At the coding stage, the design results are translated into software. The development stage will produce a computer program or application based on the system flow, database, and application interface design that has been designed at the design stage. The next stage focuses on testing the application in terms of logic and functionality and ensuring that all parts have been tested. This is done to minimize errors and ensure the results that come out are as desired.

In this study, the system testing used was Blackbox testing. The black box testing method focuses on the functional requirements of the software, thereby enabling the software engineer to derive a set of input conditions that fully utilizes all the functional requirements for a program. The flowchart of the research carried out can be seen in Figure. 3 (Kinoshita-Ise & Sachdeva, 2022).

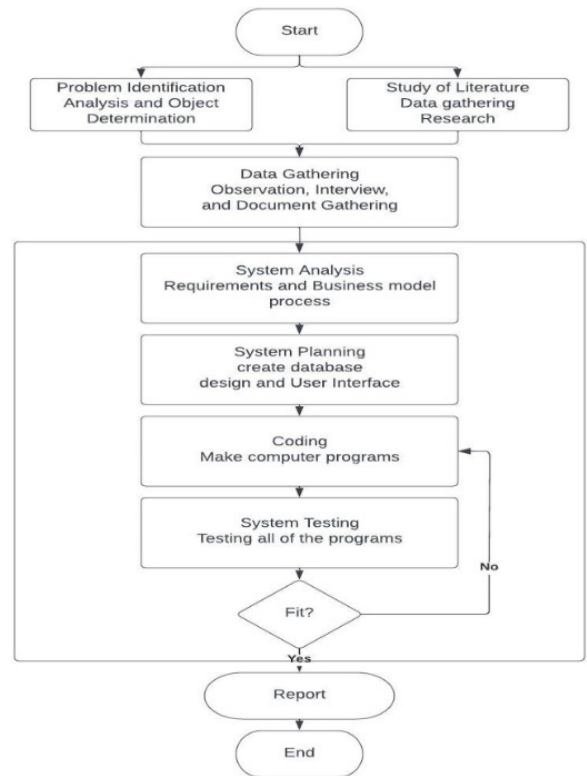

Figure 3. Research Flowchart

### 2.3 Queue Type

Queues can happen anywhere, for example, when going to the bank and the hospital. Queues exist so that when many people come to a place, it will be more organized and more space efficient. That is why queues are extremely useful in everyday life (Hu et al., 2022). We use the Multi-Channel Single Phase queuing method (Zhang et al., 2022). Because this queuing method is very suitable for the application. An example of a Figureure can be seen in Figure. 4.

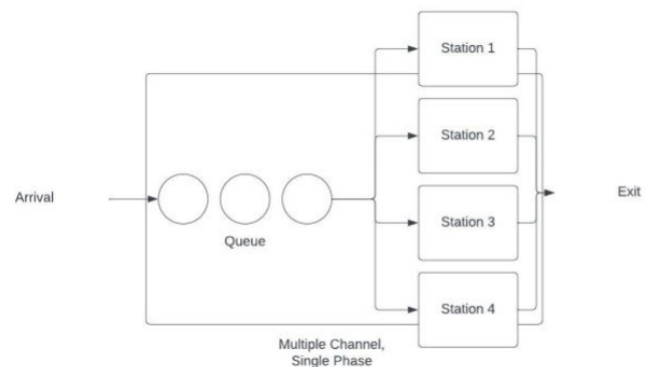

Figure 4. Multi-Channel Single Phase

As the name suggests, this queuing system has several service facilities. Even though it consists of several services, every service facility is the same. Therefore, when there is an empty service facility, customers will be directed there. In this system, before customers get service in an empty service facility, they will line up by forming a line. We can see this queuing system in the queuing system at banks, barbershops, salons, community service counters, and others. With this queuing system, customers will get service faster, so they do not have to wait too long.

### III. RESULTS AND DISCUSSION

#### 3.1 Business Process Model Nation (BPMN)

The running business process for washing is modeled using the nation's business process model (BPMN) (Pufahl et al., 2022). One of the business processes that is exemplified in the process of booking a car wash. More details can be seen in Figure. 5.

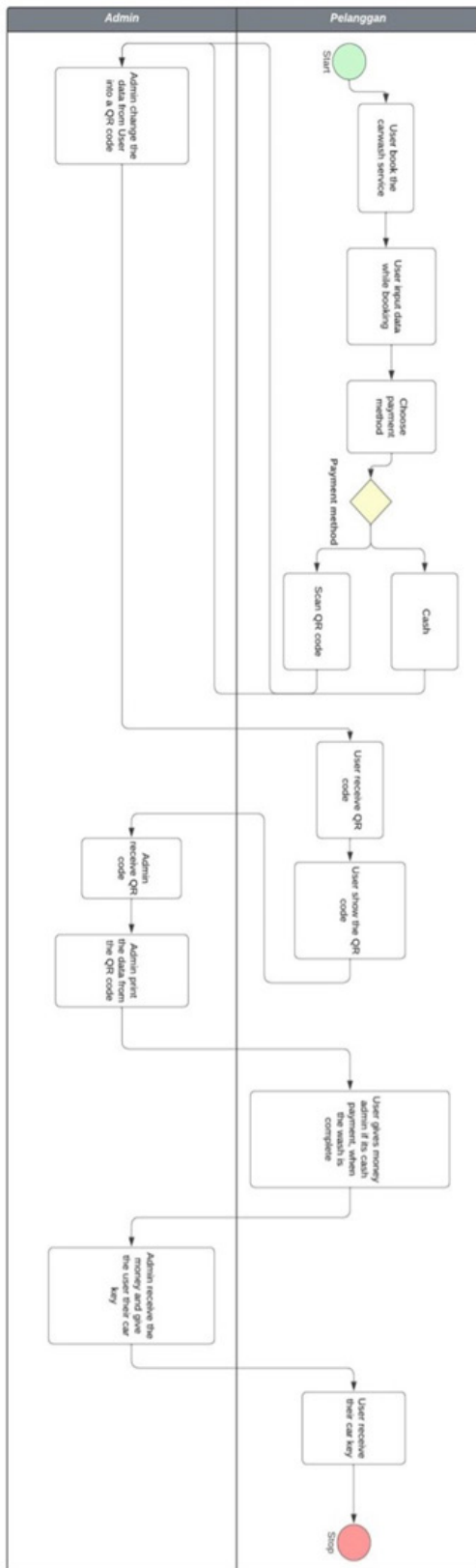

Figure 5. Business Process Model Nation (BPMN)

#### 3.2 Use Case Diagram

Each function in the system is a process that is technically carried out by the actors involved in the relationship between the functional and the actor is described by a use case diagram. The use case diagram of this application design can be seen in Figure. 6.

Based on the use case diagram of the application design in Figure 5, it is found that there are two actors involved in the application, namely admin and customer. Each actor is required to log in first before using the system. There are four functions in the web application that have a relationship with the function of each. For the admin, there are eleven functions, and the customer has three functional. Functionality in this web application was chosen based on the needs and effectiveness of the system.

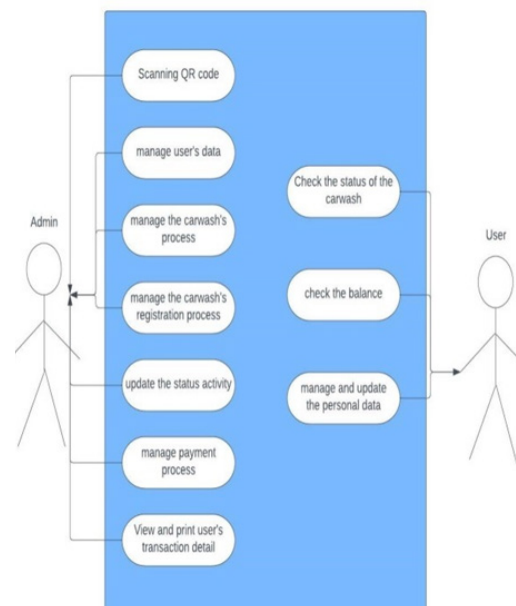

Figure 6. Use Case Diagram

#### 3.3 User Interface Application

There is a screenshot from the application. Figure 7 is the main menu page from the application. There are a few buttons that can be pressed with their respective functions.

Figure 8 above is the admin menu page from the application. In this menu, all customers who have used this application to order then order will go to the admin page, which will be processed by the admin.

Figure 9 is the Login menu page from the application. This page is useful for users or customers who want to enter the application. That way, customers can try the application.

Figure 10 is the Registration menu page from the application. This page is useful for customers or users to create an account for login.

Figure 11 is the Registration menu page from the application. This page is useful to customers or users who want to book a car wash. Users must fill in all the available fields, so the order is successful.

Figure 12 is the Registration menu page from the application. This page is useful for customers or users to

check out the QR code, which is where the QR code is useful for proof that the user has used the application for booking.

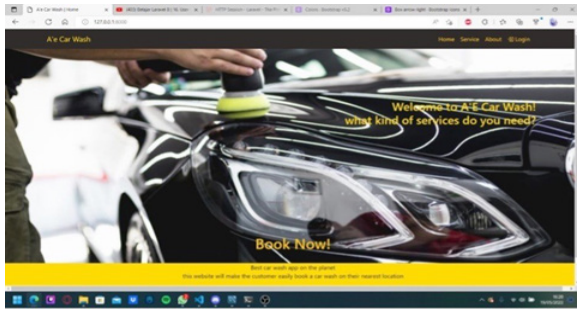

Figure 7. Main Menu

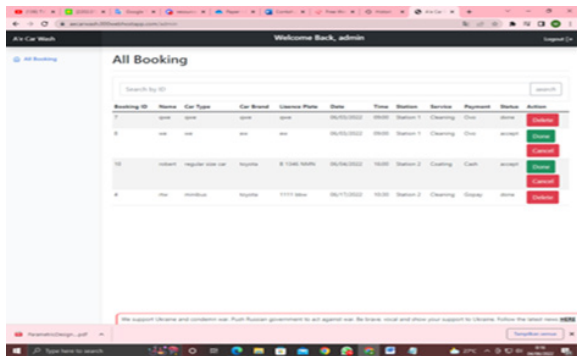

Figure 8. Admin Menu

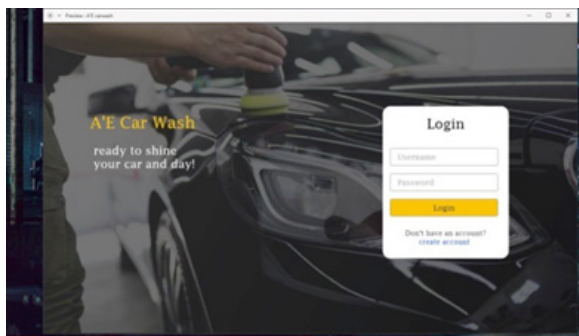

Figure 9. Login Menu

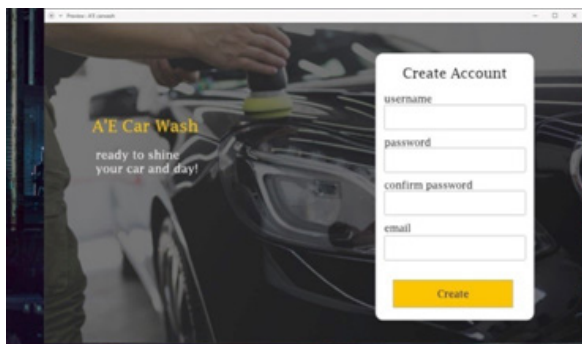

Figure 10. Registration Menu

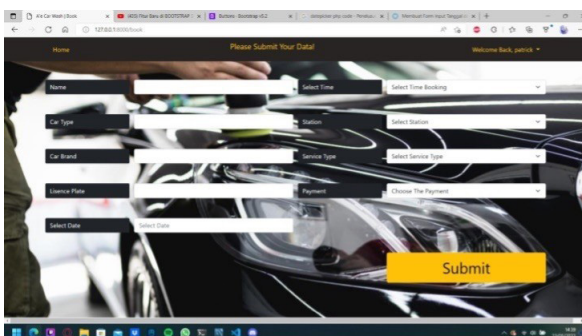

Figure 11. Booking Menu



Figure 12. QR Code Menu

### 3.4 A'e Car Was VS AUTOSPA (Other Application)

After testing, we compare our website with an existing website called AUTOSPA or another website that has the same concept as our web. The comparison between our website and the other website can be seen in Figure 13 and Figure 14. While for storage size, that is 6,119 Mb to A'e Car Wash and 4,40 Mb to Auto Spa. It can be seen below in Figure 14. From the Result test performance by loading the page above, A'e Car Wash is faster than Auto Spa from mobile and desktop versions. The result from test performance in terms of loading speed and storage found that A'e Car Wash was faster than Auto Spa in loading speed, although the required storage was bigger than A'e Car Wash than Auto Spa. With the loading speed that this app has, it will make customers comfortable because they do not have to wait long when they want to go to the next page of the application.

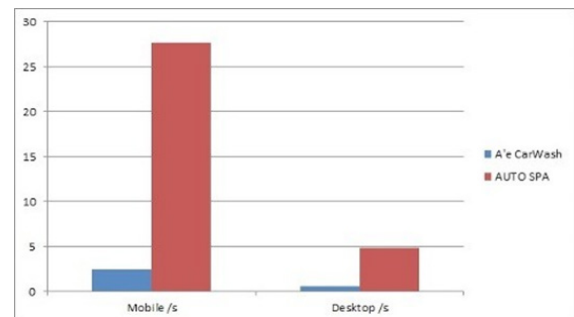

Figure 13. Loading Page Speed

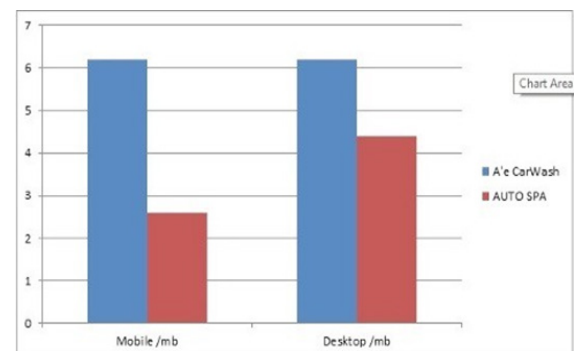

Figure 14. Storage Speed Comparison

### 3.5 Performance Comparison

Regarding page loading speed, mobile A'e Car Wash is superior to AUTOSPA. With a loading speed of 2.5 seconds for A'e Carwash and 27.64 seconds for AUTOSPA. While for page loading speed on desktop, A'e Carwash is superior to AUTOSPA. With a loading speed of 0,66

seconds for A'e Car Wash and 4,9 seconds for AUTOSPA. Can be seen below in Figure 15 – Figure 18. Furthermore, A'e Car Wash compared with AUTOSPA with storage size 61,19 KB to A'e Car Wash, and 2,60 MB.

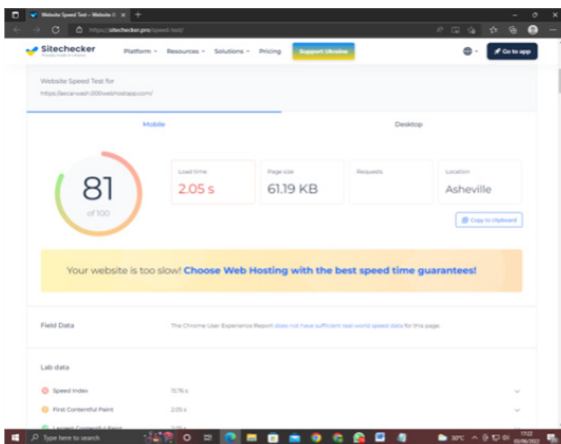

Figure 15. A'e Car Wash Performance Test in Mobile Device

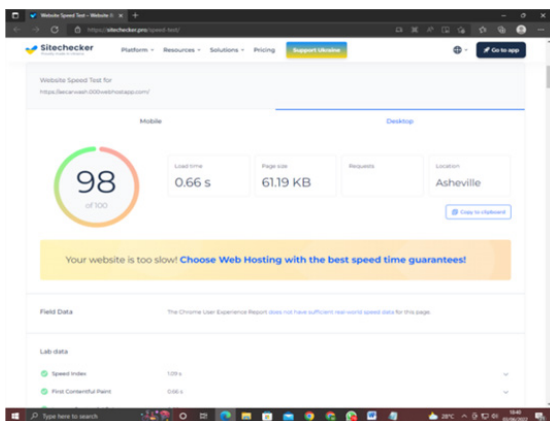

Figure 16. A'e Car Wash Performance Test in Desktop

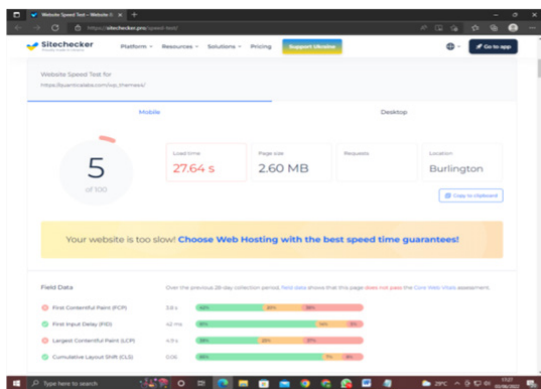

Figure 17. AUTOSPA Performance Test in Mobile Device

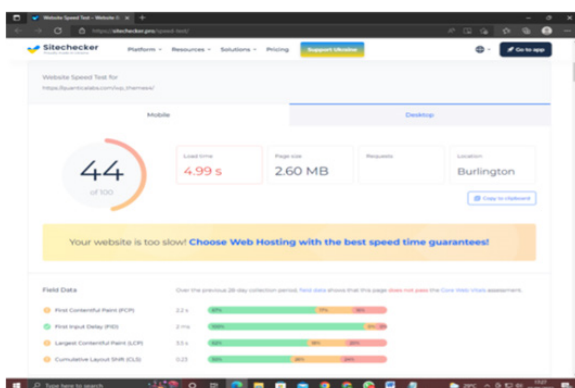

Figure 18. AUTOSPA Performance Test in Mobile Device

### 3.6 Function Comparison

In terms of function, these two websites have almost the same functions as booking, logging in, and paying. But A'e Car Wash has multiple functions. It can show the transaction details. It can show the QR code of the transaction. While Auto Spa only has a booking page, the user cannot see the transaction details.

### 3.7 Design Comparison

A'e Car Wash has multiple pages: booking pages, a home page, and the transaction detail page that makes it easy for customers to use. While Auto Spa only has one page, the user can book and input data on the same page. This website for login function put the button in the web footer. It can make customers confused when they want to log in. While A'e Car Wash login function is put in the header of the web, and this web requires customers to log in first before making a booking.

## IV. CONCLUSION

This website was created to make customers easier to book car wash services from anywhere. Because we create it with the database so the order data/transaction details can be easily accessed by users. This website can prevent customers from long queues during the car wash process. Because users can check the availability of date, time, and service stations. Furthermore, our team would like to develop this application into a mobile app.

## REFERENCES

Ahmed, U., & Roorda, M. J. (2022). Modelling carrier type and vehicle type choice of small and medium size firms. *Transportation Research Part E: Logistics and Transportation Review*, 160, 102655. <https://doi.org/10.1016/J.TRE.2022.102655>

Bach, S. H., Sanh, V., Yong, Z.-X., Webson, A., Raffel, C., Nayak, N. v, Sharma, A., Kim, T., Bari, M. S., & Fevry, T. (2022). Promptsources: An integrated development environment and repository for natural language prompts. *ArXiv Preprint ArXiv:2202.01279*.

Bu, Q.-H., Liu, L.-W., Tang, J.-S., & Zhao, Y.-Q. Q. (2022). Approximations for a Queuing Game Model with Join-the-Shortest-Queue Strategy. *Journal of the Operations Research Society of China*, 1–16.

Castro-Medina, F., Rodriguez-Mazahua, L., López-Chau, A., Abud-Figureueroa, M. A., & Alor-Hernández, G. (2020). FRAGMENT: a web application for database fragmentation, allocation and replication over a cloud environment. *IEEE Latin America Transactions*, 18(06), 1126–1134.

Chandran, K., & das Aundhe, M. (2022). Agile or waterfall development: The Clementon Company dilemma. *Journal of Information Technology Teaching*

*Cases*, 12(1), 8–15.

- Dux-Santoy, L., Rodríguez-Palomares, J. F., Teixidó-Turà, G., Ruiz-Muñoz, A., Casas, G., Valente, F., Servato, M. L., Galian-Gay, L., Gutiérrez, L., & González-Alujas, T. (2022). Registration-based semi-automatic assessment of aortic diameter growth rate from contrast-enhanced computed tomography outperforms manual quantification. *European Radiology*, 32(3), 1997–2009.
- Egelhofer, J. L., & Lecheler, S. (2019). Fake news as a two-dimensional phenomenon: A framework and research agenda. *Annals of the International Communication Association*, 43(2), 97–116.
- Guan, Y., Wu, B., & Jia, J. (2020). Does online ticket booking system make people better off? An empirical study on railway service. *Transportation Research Part F: Traffic Psychology and Behaviour*, 73, 143–154.
- Harun, M. K., Yuniati, D., Khotimah, H., Qirom, M. A., Hero, Y., Putra, E. I., Pamungkas, P., Sukendro, A., Asterina, P. N., & Nurhayati, A. D. (2022). Multi-Business based on landscapes agroforestry to improve connectivity of Kahayan-Sebangau Peat Hidrological Unit Central Kalimantan. *IOP Conference Series: Earth and Environmental Science*, 959(1), 012069.
- Hu, S., Zhou, Q., Li, J., Wang, Y., Roncoli, C., Zhang, L., & Lehe, L. (2022). High Time-Resolution Queue Profile Estimation at Signalized Intersections Based on Extended Kalman Filtering. *IEEE Transactions on Intelligent Transportation Systems*.
- Kafiev, I., Romanov, P., & Romanova, I. (2020). Control System of Portal Car Wash based on the Mamdani Fuzzy Algorithm. *2020 International Multi-Conference on Industrial Engineering and Modern Technologies (FarEastCon)*, 1–6.
- Kinoshita-Ise, M., & Sachdeva, M. (2022). Update on trichoscopy: Integration of the terminology by systematic approach and a proposal of a diagnostic flowchart. *The Journal of Dermatology*, 49(1), 4–18.
- Laaziri, M., Benmoussa, K., Khoulji, S., & Kerkeb, M. L. (2019). A Comparative study of PHP frameworks performance. *Procedia Manufacturing*, 32, 864–871.
- Liu, Y., Yang, J., & Liu, M. (2008). Recognition of QR Code with mobile phones. *2008 Chinese Control and Decision Conference*, 203–206.
- Muryani, A. S., & Muqorobin, M. (2020). Decision Support System Using Cloud-Based Moka Pos Application To Easy In Input In Orange Carwash Blulukan Flash N0. 110 Colomadu. *International Journal of Computer and Information System (IJCIS)*, 1(3), 66–69.
- Othman, A. M., & Ramli, A. A. (2021). Aplikasi Pengurusan Fazira Car Wash Menggunakan Android (Fazira2Clean). *Applied Information Technology And Computer Science*, 2(2), 1046–1061.
- Pertama, A. P., Afriani, S., & Gayatri, I. A. M. E. M. (2022). Analysis of the Queuing System for the Indonesian Islamic Bank (BSI) Bengkulu Branch. *Jurnal Ekonomi, Manajemen, Akuntansi Dan Keuangan*, 3(1), 70–80.
- Pufahl, L., Zerbato, F., Weber, B., & Weber, I. (2022). BPMN in healthcare: Challenges and best practices. *Information Systems*, 107, 102013.
- Putra, E. R. (n.d.). *Web-Based Futsal Field Rental Information System Using Laravel Framework*.
- Reddy, C. S., & Savant, P. (n.d.). *A Survey on Car Service Slot Booking System*.
- Saito, T., Takahashi, A., Koide, N., & Ichifuji, Y. (2019). Application of online booking data to hotel revenue management. *International Journal of Information Management*, 46, 37–53.
- Saputra, R. A., Parjito, P., & Wantoro, A. (2020). Implementasi Metode Jackson Network Queue Pada Pemodelan Sistem Antrian Booking Pelayanan Car Wash (Studi Kasus: Autoshine Car Wash Lampung). *Jurnal Teknologi Dan Sistem Informasi*, 1(2), 80–86.
- Shafique, K., Khawaja, B. A., Sabir, F., Qazi, S., & Mustaqim, M. (2020). Internet of things (IoT) for next-generation smart systems: A review of current challenges, future trends and prospects for emerging 5G-IoT scenarios. *Ieee Access*, 8, 23022–23040.
- Srivastava, A., Khadke, L., & Chinnasamy, P. (2022). Developing a web application-based water budget calculator: attaining water security in Rural-Nashik, India. In *Climate Change and Water Security* (pp. 473–492). Springer.
- Teow, Y. H., Ho, K. C., Wickramasinghe, S. R., Jebur, M. G., & Chang, Z. H. (2022). Integrated process technology for recycling and re-use of industrial and municipal wastewater: A review. *Integrated Environmental Technologies for Wastewater Treatment and Sustainable Development*, 49–80.
- Tiwari, S. (2016). An introduction to QR code technology. *2016 International Conference on Information Technology (ICIT)*, 39–44.
- Tony, M. A., & Lin, L.-S. (2021). Performance of acid mine drainage sludge as an innovative catalytic oxidation source for treating vehicle-washing wastewater. *Journal of Dispersion Science and Technology*, 43(1), 50–60.
- Yuliarisa, Y., & Yandari, A. D. (2022). ANALISIS PERKEMBANGAN TINGKAT LITERASI KEUANGAN PENGGUNA FINTECH PADA PELAKU USAHA MIKRO DI KABUPATEN

SUMENEP (STUDI KASUS USAHA MIKRO PENGGUNA FINTECH PAYMENT SHOP-EEPAY DAN OVO). *PERFORMANCE: Jurnal Bisnis & Akuntansi*, 12(1), 63–71.

Zhang, K., Chi, X., Nan, Z., Li, Y., & Wang, N. (2022). Numerical simulation for condensation in the presence of noncondensable gas in the condenser with a multi-channel structure. *Applied Thermal Engineering*, 209, 118260.